

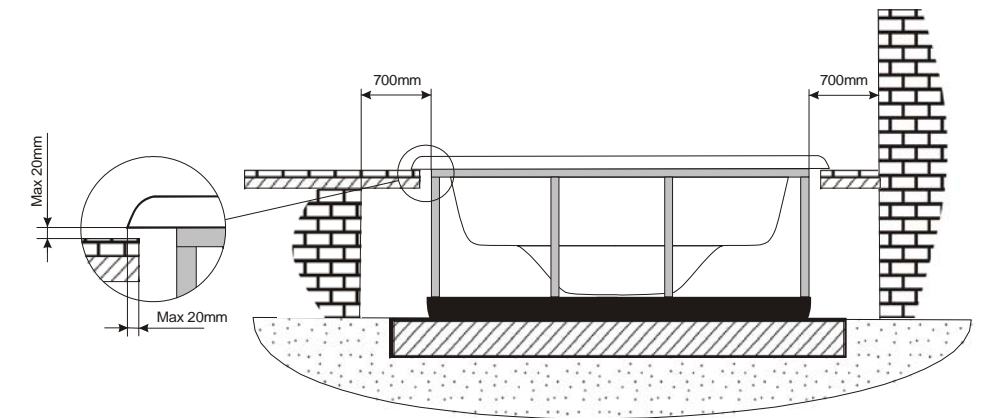

Inground option

WARNING:

It's essential to keep a minimum clearance access of **700mm** all around.



According to our policy of continuous improvement, dimensions, features or components of this product can be partially or completely changed without prior notice. It's Customer responsibility to verify that this is the last version of the drawing

09	22/10/2014	I.Pozo	Change scale and new spare template
08	07/03/2014	X.Codina	New templates
Change No.	Date	Name	Modification
Remarks			COMMERCIAL
Dimensions in mm. General Tolerances +/- 10mm			
Drawn	13/11/2013	X.Codina	
Checked	--	--	
Scale 1:15	General Tolerance		
Sheet 1/2	DIN 7168 ISO 2768g		
			Part Number
			41578
			Rev.
			09
			First Angle Projection
			

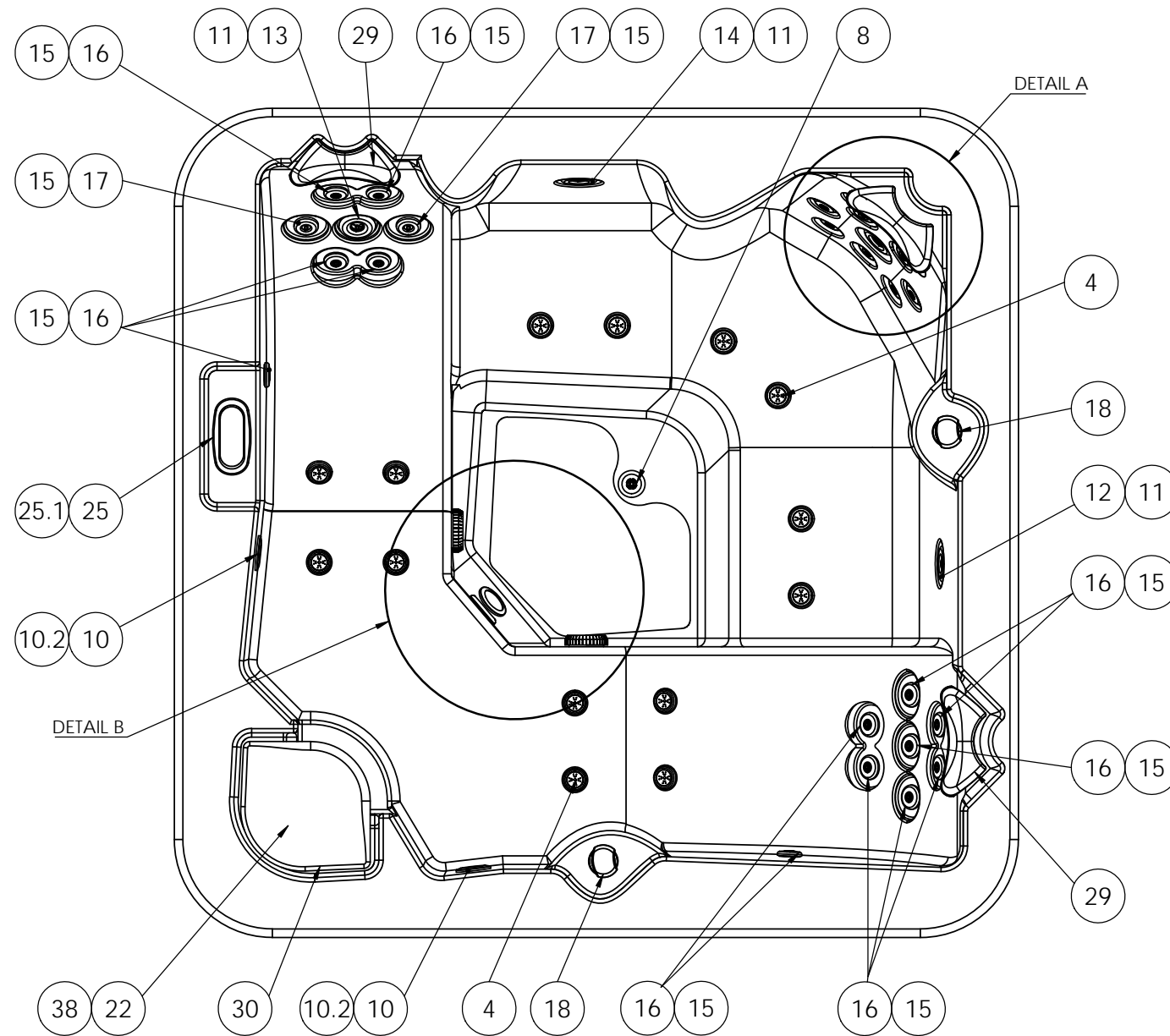

PUMPS SPARE CODES

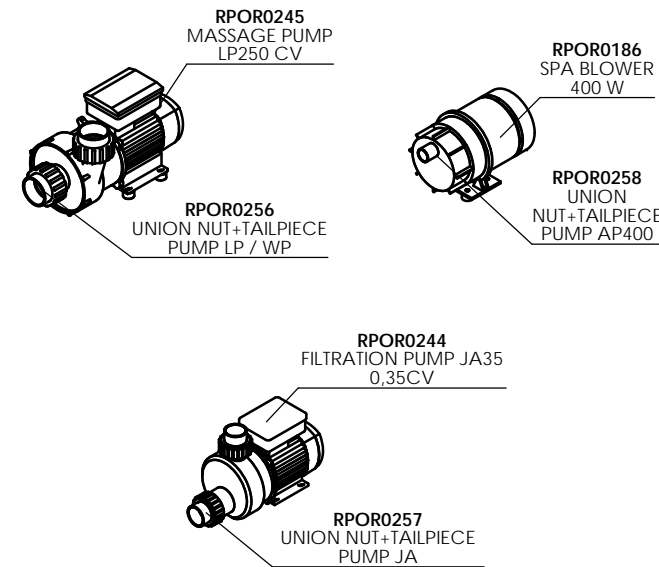

ACCESSORIES			
Position Num.	Part Nº SPARE	Description SPARE	Quant.
2	RPOR0225	GREY SPA DRAIN 2" ADAPTOR SOCKET D.50	2
4	REMP0046	WHITE-STAINLESS STEEL AIR NOZZLE	14
8	RPOR0003	GREY DRAIN SET - BODY+COVER+ASSEMBLY	1
10	RPOR0239	SPOTLIGHT LED SET RD	OP.
10.1	RPOR0240	MASTER LED LIGHT	OP.
10.2	RPOR0252	LED SLAVE LIGHT	OP.
11	RPOR0236	JET BODY SET RD 3"	5
12	RPOR0231	FRONTAL JET 3" STAINLESS STEEL DIRECTIONAL	2
13	RPOR0232	FRONTAL JET 3" STAINLESS STEEL 1 JET ROTO	2
14	RPOR0233	FRONTAL JET 3" STAINLESS STEEL TWIN ROTO	1
15	RPOR0235	JET BODY SET RD 2"	25
16	RPOR0230	FRONTAL JET 2" STAINLESS STEEL DIRECTIONAL	17
17	RPOR0260	JET TWIN ROTO 2" INOX	8
18	RPOR0261	VENTURY CONTROLLER SS	2
22	RPOR0238	SKIMERFILTER RD LOW PROFILE	1
25	RPOR0241	CONTROL PANEL VL600S	1
25.1	RPOR0243	COVER DIGITAL PANEL VL600S MASSAGE + BLOWER	1
29	RPOR0095	SMALL HEADREST - PACIFIC-ANTARTIC	3
30	RPOR0156	SKIMFILTER COVER	1
38	RPOR0247	FILTER CARTRIDGE SKIMFILTER RD	1
49	RPOR0136	DRAIN FILL VALVE (BLACK)	1

HEATER AND DESINFECTATION SPARE CODES

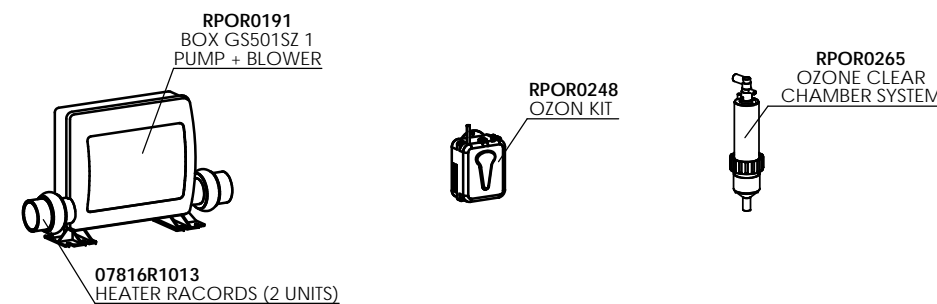

RPOR0101 - TEMPERATURE PROBES GS I GL (x 2)
 RPOR0105 - HEATER 3 KW GS I GL
 RPOR0197 - DIGITAL PANEL GS501SZ

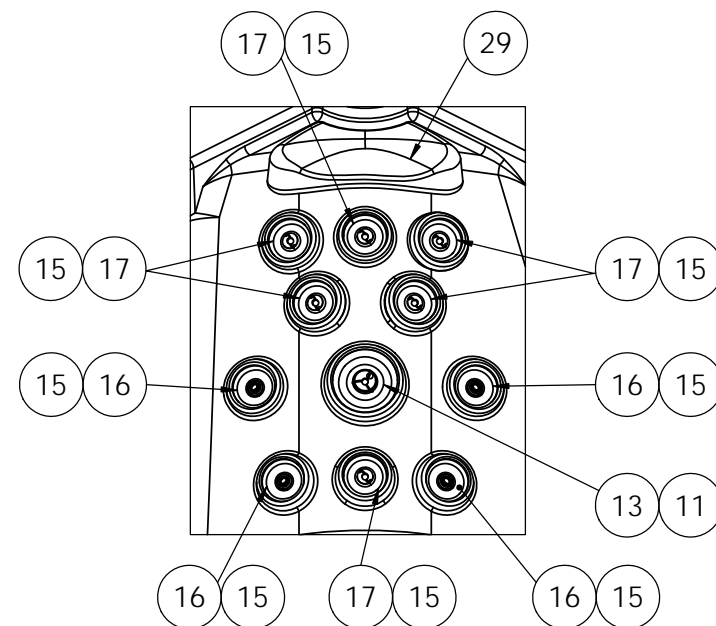

A (1 : 10)

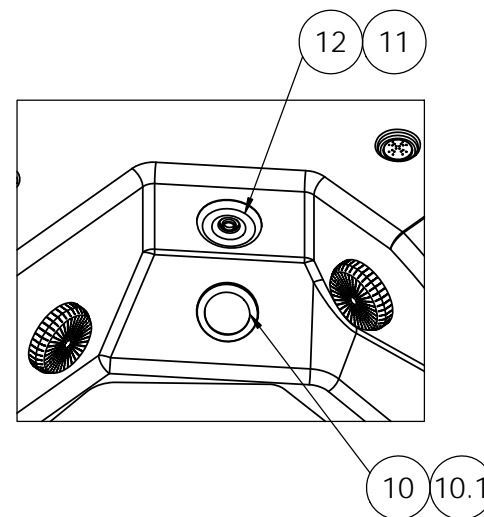

B (1 : 10)

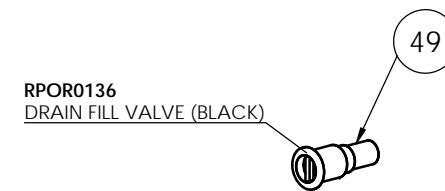

According to our policy of continuous improvement, dimensions, features or components of this product can be partially or completely changed without prior notice. It's Customer responsibility to verify that this is the last version of the drawing

Change No.	Date	Name	Modification
09	22/10/2014	I.Pozo	Change scale and new spare template
08	07/03/2014	X.Codina	New templates

Remarks Dimensions in mm. General Tolerances +/- 10mm		SPARE PARTS DRAWING		
Drawn	13/11/2013	X.Codina	Part Number	Rev.
Checked	--	--	41578	09
Scale 1:15	General Tolerance DIN 7168 ISO 2768g			First Angle Projection
Sheet 2/2				

Property of IBERSPA S.L. Avda. Pla d'Urgell 2-8 25200 Cervera, Spain. Don't use without permission. Keep this information confidential and use it solely for the permitted purpose.